

### N-channel Enhanced mode TO-252 MOSFET

#### Features

- High ruggedness
- Low  $R_{DS(ON)}$  (Typ 6.7m $\Omega$ ) @  $V_{GS}=10V$
- Low Gate Charge (Typ 128nC)
- Improved dv/dt Capability
- 100% Avalanche Tested
- Application: Synchronous Rectification, Li Battery Protect Board, Motor Drivers

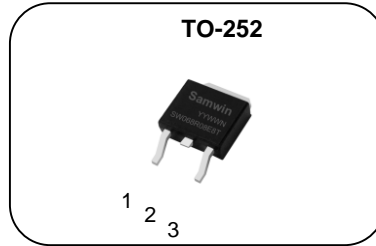

1. Gate 2. Drain 3. Source

$BV_{DSS}$ : 80V
$I_D$ : 100A
$R_{DS(ON)}$ : 6.7m $\Omega$

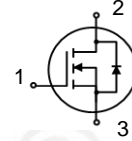

#### General Description

This power MOSFET is produced with advanced technology of SAMWIN. This technology enable the power MOSFET to have better characteristics, including fast switching time, low on resistance, low gate charge and especially excellent avalanche characteristics.

#### Order Codes

Item	Sales Type	Marking	Package	Packaging
1	SW D 068R08E8T	SW068R08E8T	TO-252	REEL

#### Absolute maximum ratings

Symbol	Parameter	Value	Unit
$V_{DSS}$	Drain to source voltage	80	V
$I_D$	Continuous drain current (@ $T_C=25^\circ C$ )	100*	A
	Continuous drain current (@ $T_C=100^\circ C$ )	66*	A
$I_{DM}$	Drain current pulsed (note 1)	400	A
$V_{GS}$	Gate to source voltage	$\pm 20$	V
$E_{AS}$	Single pulsed avalanche energy (note 2)	342	mJ
$E_{AR}$	Repetitive avalanche energy (note 1)	30	mJ
dv/dt	Peak diode recovery dv/dt (note 3)	5	V/ns
$P_D$	Total power dissipation (@ $T_C=25^\circ C$ )	125	W
	Derating factor above 25 $^\circ C$	1.0	W/ $^\circ C$
$T_{STG}, T_J$	Operating junction temperature & storage temperature	-55 ~ + 150	$^\circ C$

\*. Drain current is limited by junction temperature.

#### Thermal characteristics

Symbol	Parameter	Value	Unit
$R_{thjc}$	Thermal resistance, Junction to case	1.0	$^\circ C/W$

## Electrical characteristic ( $T_J = 25^\circ\text{C}$ unless otherwise specified )

Symbol	Parameter	Test conditions	Min.	Typ.	Max.	Unit
<b>Off characteristics</b>						
$BV_{DSS}$	Drain to source breakdown voltage	$V_{GS}=0V, I_D=250\mu A$	80			V
$\Delta BV_{DSS} / \Delta T_J$	Breakdown voltage temperature coefficient	$I_D=250\mu A$ , referenced to $25^\circ\text{C}$		0.04		V/ $^\circ\text{C}$
$I_{DSS}$	Drain to source leakage current	$V_{DS}=80V, V_{GS}=0V$			1	$\mu A$
		$V_{DS}=64V, T_J=125^\circ\text{C}$			50	$\mu A$
$I_{GSS}$	Gate to source leakage current, forward	$V_{GS}=20V, V_{DS}=0V$			100	nA
	Gate to source leakage current, reverse	$V_{GS}=-20V, V_{DS}=0V$			-100	nA
<b>On characteristics</b>						
$V_{GS(TH)}$	Gate threshold voltage	$V_{DS}=V_{GS}, I_D=250\mu A$	2		4	V
$R_{DS(ON)}$	Drain to source on state resistance	$V_{GS}=10V, I_D=30A, T_J=25^\circ\text{C}$		6.7	8	m $\Omega$
		$V_{GS}=10V, I_D=30A, T_J=125^\circ\text{C}$		10.4		m $\Omega$
$G_{fs}$	Forward transconductance	$V_{DS}=5V, I_D=30A$		58		S
<b>Dynamic characteristics</b>						
$C_{iss}$	Input capacitance	$V_{GS}=0V, V_{DS}=40V, f=1\text{MHz}$		6242		pF
$C_{oss}$	Output capacitance			340		
$C_{riss}$	Reverse transfer capacitance			282		
$t_{d(on)}$	Turn on delay time	$V_{DS}=40V, I_D=30A, R_G=4.7\Omega, V_{GS}=10V$ (note 4,5)		27		ns
$t_r$	Rising time			60		
$t_{d(off)}$	Turn off delay time			94		
$t_f$	Fall time			37		
$Q_g$	Total gate charge	$V_{DS}=64V, V_{GS}=10V, I_D=30A, I_G=4\text{mA}$ (note 4,5)		128		nC
$Q_{gs}$	Gate-source charge			28		
$Q_{gd}$	Gate-drain charge			44		
$R_g$	Gate resistance		$V_{DS}=0V$ , Scan F mode		2.4	

## Source to drain diode ratings characteristics

Symbol	Parameter	Test conditions	Min.	Typ.	Max.	Unit
$I_S$	Continuous source current	Integral reverse p-n Junction diode in the MOSFET			100	A
$I_{SM}$	Pulsed source current				400	A
$V_{SD}$	Diode forward voltage drop.	$I_S=45A, V_{GS}=0V$			1.4	V
$t_{rr}$	Reverse recovery time	$I_S=30A, V_{GS}=0V, di/dt=100A/\mu s$		37		ns
$Q_{rr}$	Reverse recovery charge				56	nC

### ※. Notes

1. Repeattive rating : pulse width limited by junction temperature.
2.  $L=0.5\text{mH}, I_{AS}=37A, V_{DD}=50V, R_G=25\Omega$ , Starting  $T_J=25^\circ\text{C}$
3.  $I_{SD} \leq 30A, di/dt = 100A/\mu s, V_{DD} \leq BV_{DSS}$ , Starting  $T_J=25^\circ\text{C}$
4. Pulse Test : Pulse Width  $\leq 300\mu s$ , duty cycle  $\leq 2\%$ .
5. Essentially independent of operating temperature.

**Fig. 1. On-state characteristics**

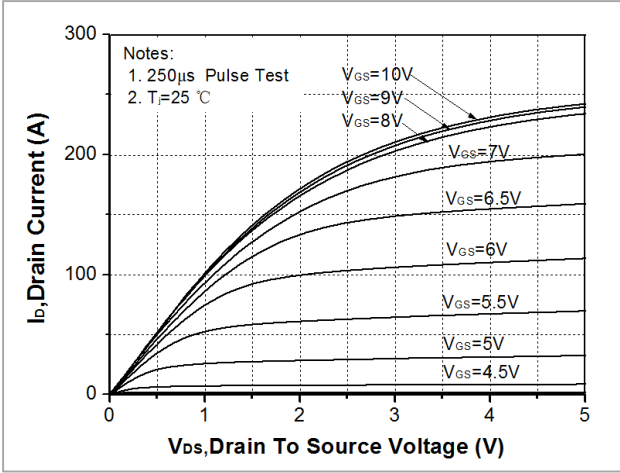

**Fig. 2. Transfer Characteristics**

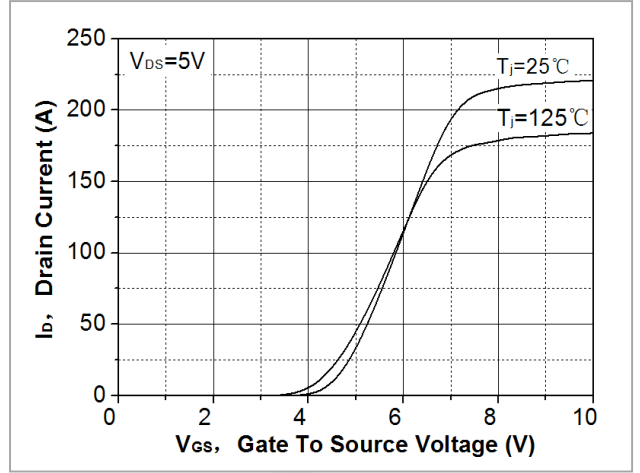

**Fig. 3. On-resistance variation vs. drain current and gate voltage**

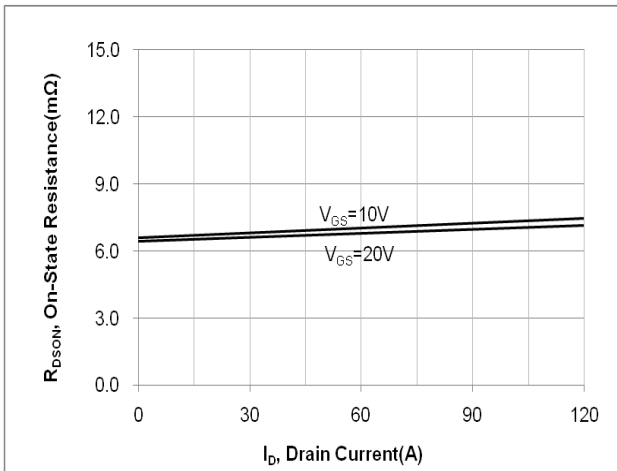

**Fig. 4. On-state current vs. diode forward voltage**

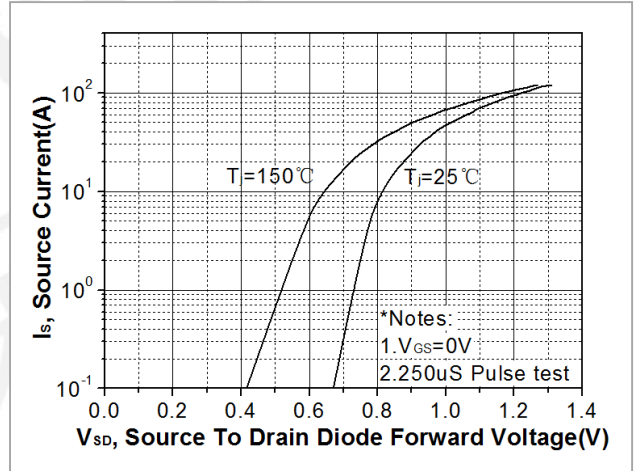

**Fig 5. Breakdown voltage variation vs. junction temperature**

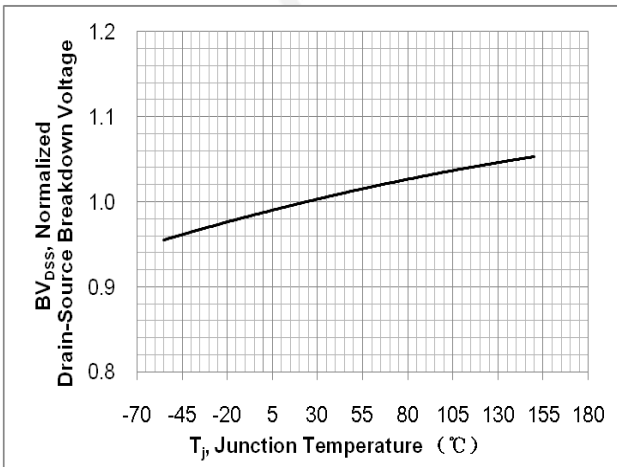

**Fig. 6. On-resistance variation vs. junction temperature**

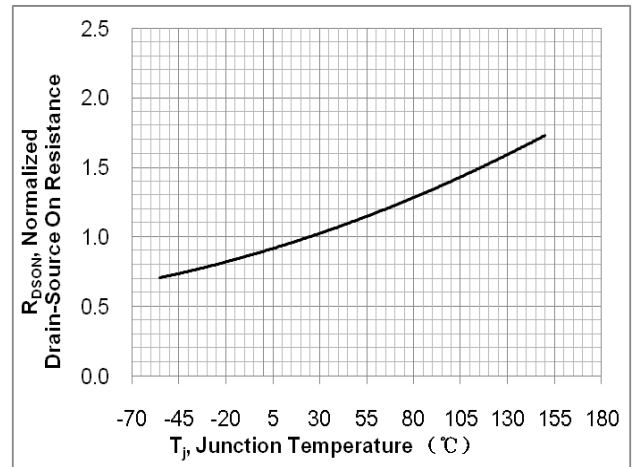

Fig. 7. Gate charge characteristics

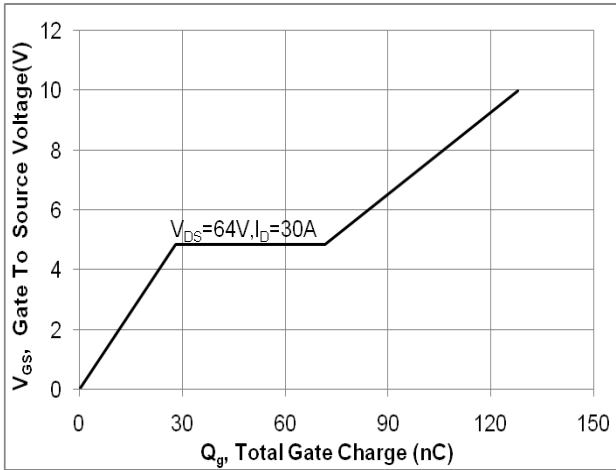

Fig. 8. Capacitance Characteristics

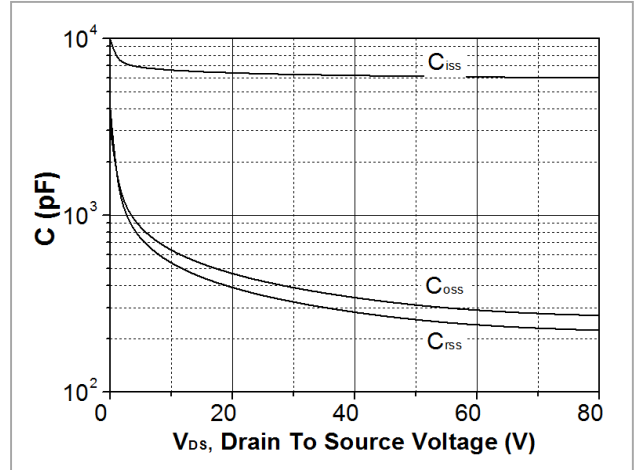

Fig. 9. Maximum safe operating area

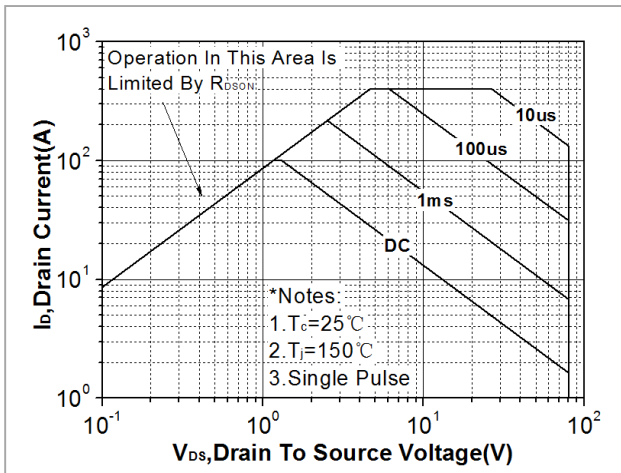

Fig. 10. Maximum drain current vs. case temperature

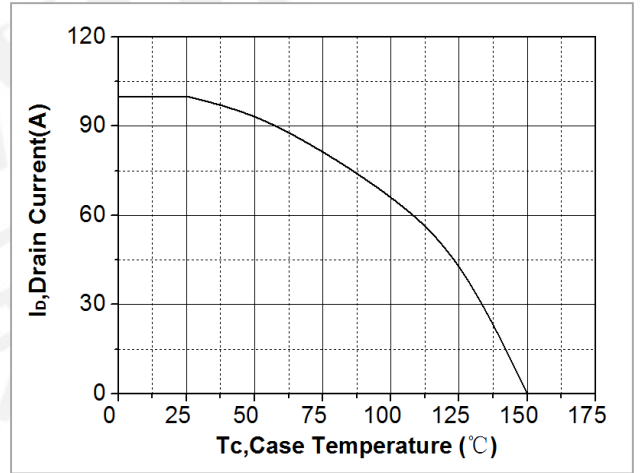

Fig. 11. Transient thermal response curve

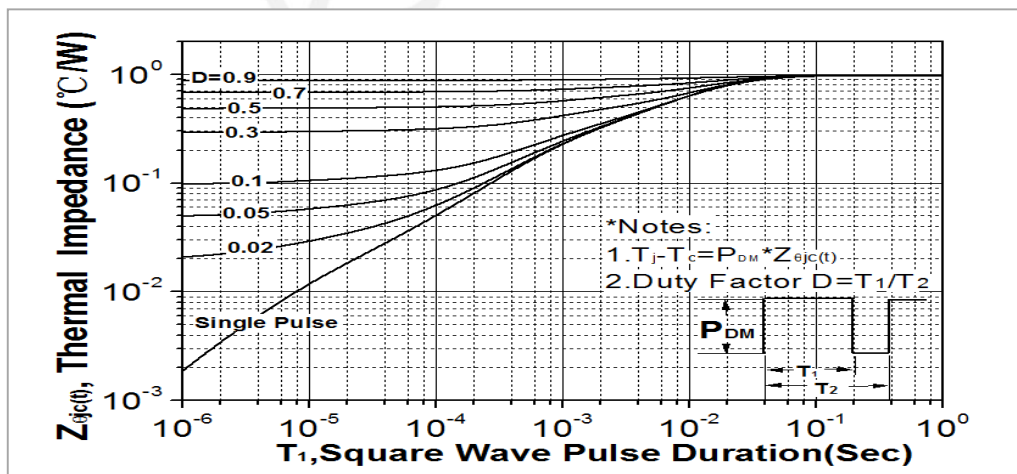

Fig. 12. Gate charge test circuit & waveform

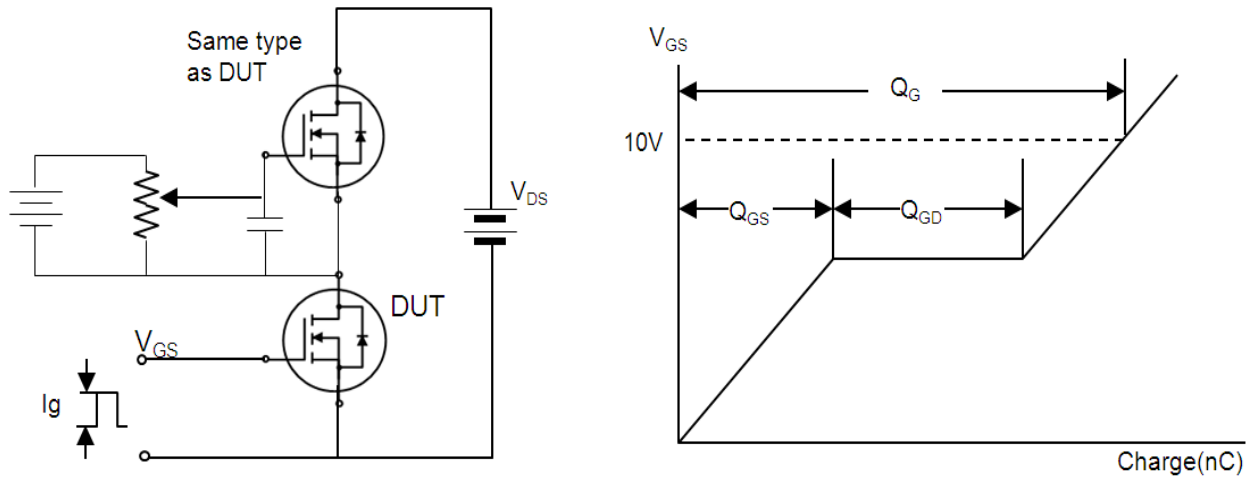

Fig. 13. Switching time test circuit & waveform

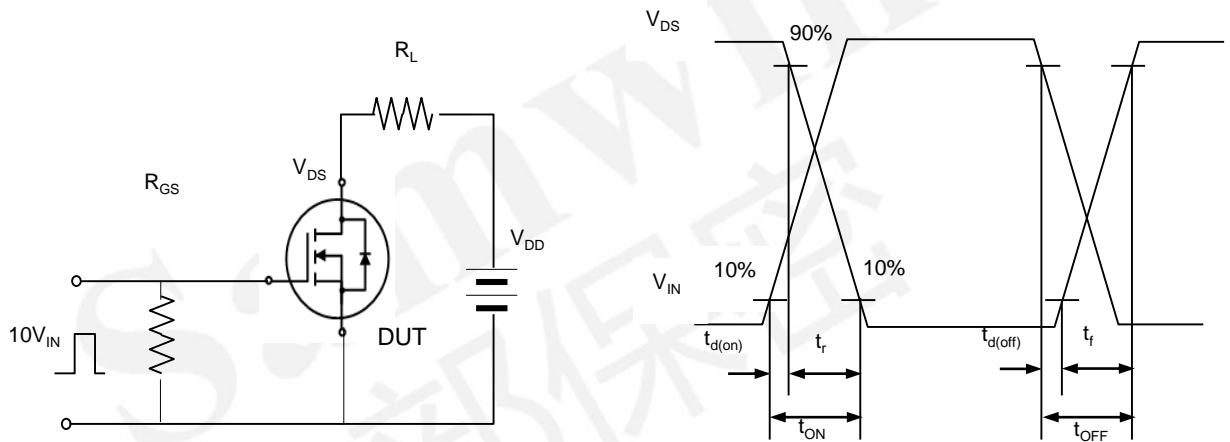
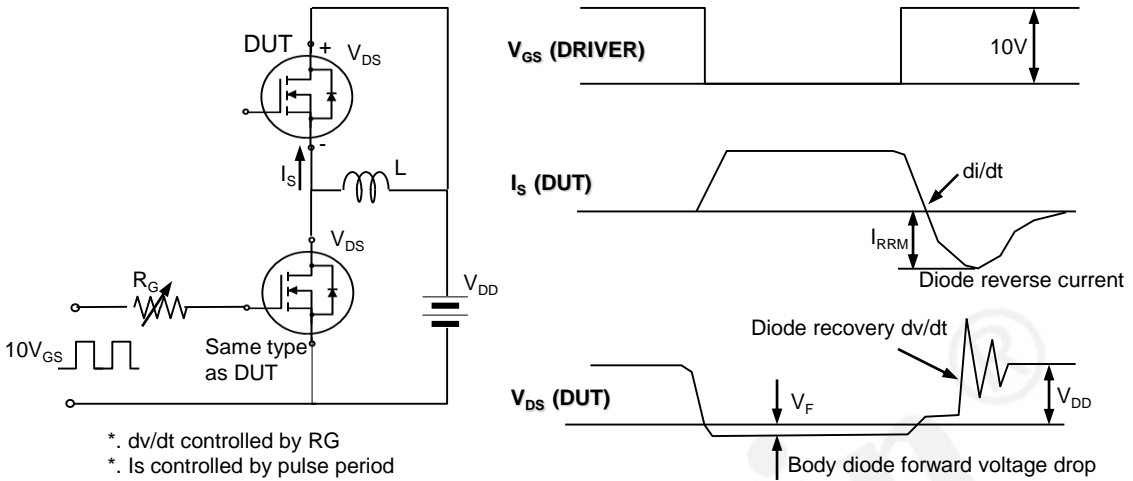

Fig. 14. Unclamped Inductive switching test circuit & waveform



Fig. 15. Peak diode recovery dv/dt test circuit & waveform



### DISCLAIMER

\* All the data & curve in this document was tested in SEMIPOWER TESTING & APPLICATION CENTER.

\* This product has passed the PCT,TC,HTRB,HTGB,HAST,PC and Solderdunk reliability testing.

\* Qualification standards can also be found on the Web site (<http://www.semipower.com.cn>)



\* Suggestions for improvement are appreciated, Please send your suggestions to [samwin@samwinsemi.com](mailto:samwin@samwinsemi.com)